

July 28, 1959

S. E. LOVER

2,896,491

MAGNETIC PICKUP FOR STRINGED MUSICAL INSTRUMENT

Filed June 22, 1955

2 Sheets-Sheet 2

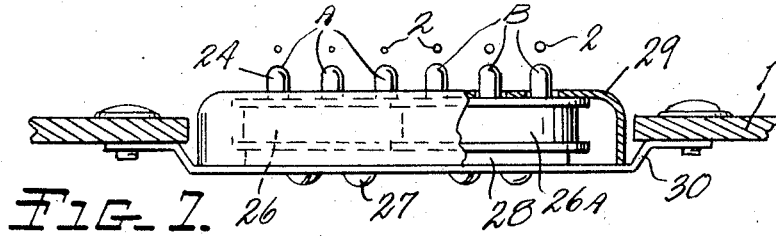

FIG. 7.

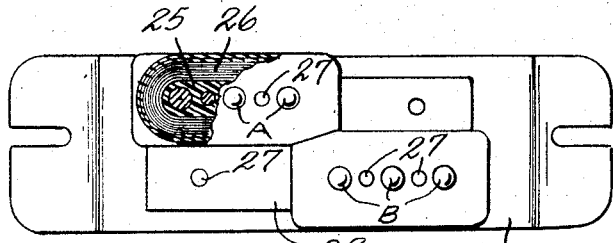

FIG. 8.

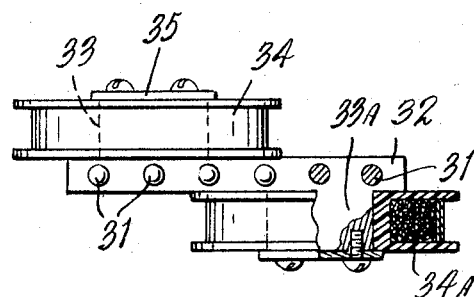

FIG. 9.

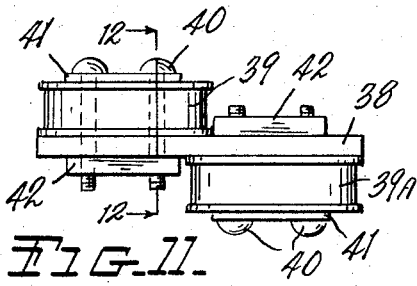

FIG. 11.

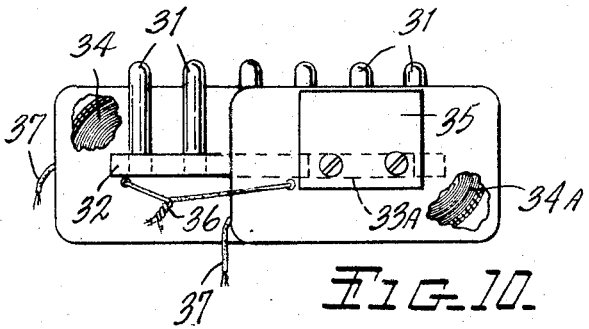

FIG. 10.

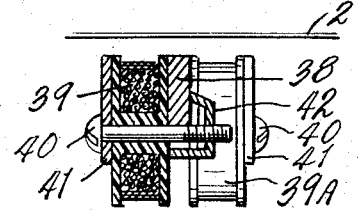

FIG. 12.

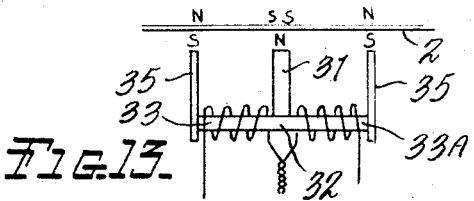

FIG. 13.

INVENTOR.
 Seth E. Lover
 BY
[Signature]
 Attorney.

1

2

2,896,491

MAGNETIC PICKUP FOR STRINGED MUSICAL INSTRUMENT

Seth E. Lover, Kalamazoo, Mich., assignor to Gibson, Inc., Kalamazoo, Mich.

Application June 22, 1955, Serial No. 517,171

1 Claim. (Cl. 84—1.15)

This invention relates to improvements in magnetic pickup for stringed musical instrument. The principal objects of this invention are:

First, to provide a magnetic pickup for a stringed musical instrument which is not affected by adjacent electrical devices and which does not pick up and transmit to the amplifier the hum of such devices.

Second, to provide an electromagnetic pickup for stringed musical instruments with magnetically opposed pickup coils that neutralize the effect of currents induced by adjacent electrical devices.

Third, to provide a hum neutralizing magnetic pickup that is efficient in producing electrical vibrations in response to the playing of a stringed instrument.

Fourth, to provide a magnetic pickup that effectively employs relatively small masses of permanent magnet material and is easily mounted on a stringed musical instrument in proper relation to the strings of the instrument.

Fifth, to provide a magnetic pickup having a metallic magnetic return circuit between a pole of the permanent magnet and a coating string of a musical instrument to increase the strength of the magnetic field around the string and improve the efficiency of the permanent magnet.

Other objects and advantages of the invention will be apparent from a consideration of the following description and claim. The drawings, of which there are two sheets, illustrate a preferred and several modified forms of magnetic pickups embodying principles of the invention.

Fig. 1 is a plan view of a stringed musical instrument having metallic strings and having the preferred form of the magnetic pickup mounted thereon.

Fig. 2 is an enlarged fragmentary plan view of the pickup shown in Fig. 1 with parts broken away in horizontal cross section.

Fig. 3 is an enlarged vertical transverse cross sectional view through the pickup taken along the plane of the line 3—3 in Fig. 2.

Fig. 4 is a fragmentary longitudinal cross sectional view through the pickup taken along the plane of the line 4—4 in Fig. 3.

Fig. 5 is a bottom plan view of the pickup with the case removed.

Fig. 6 is a schematic view illustrating the electrical and magnetic circuits in the pickup in association with an external source of interfering magnetic energy.

Fig. 7 is a fragmentary vertical cross sectional view through the top panel of a stringed musical instrument with a modified form of pickup mounted therein.

Fig. 8 is a plan view of the pickup shown in Fig. 7 with the cover removed and portions broken away in horizontal cross section.

Fig. 9 is a top plan view of a second modified form of pickup with portions broken away in horizontal cross section.

Fig. 10 is a side elevational view of the pickup shown

in Fig. 9 with portions broken away to illustrate the position of the coils.

Fig. 11 is a top plan view of a third modified form of the pickup.

Fig. 12 is a vertical cross sectional view taken along the plane of the line 12—12 in Fig. 11.

Fig. 13 is a schematic view illustrating the electrical and magnetic circuits in Figs. 9 to 12.

Magnetic pickups for stringed musical instruments having steel strings are well known and heretofore have consisted essentially of a coil wound around a permanent magnet core with a string of the instrument passing in proximity to the core so that vibration of the string will vary the magnetic field through the core and induce an electrical current in the coil capable of being amplified and passed through a loud speaker for amplifying the sound of the instrument. Stringed musical instruments and magnetic pickups of this type have been subject to the undesirable creation of hum noises in the amplifier by reasons of electrical devices in proximity to the pickup which create undesired interfering currents in the coil. The present invention eliminates the undesirable hum by neutralizing undesired induced currents in the pickup coil before they can be amplified and reproduced. Fig. 1 of the drawings illustrates a guitar 1 or other stringed musical instrument having metallic strings 2 stretched over a magnetic pickup device generally indicated at 3. The coils of the pickup device are connected to a jack 4 by means of which the pickup can be electrically connected to an amplifier and loud speaker in a well known manner.

As is more clearly illustrated in Figs. 2 to 5 the pickup 3 includes a case 5 of non-magnetic material having a removable bottom panel 6 with ears 7 projecting from each end thereof. A mounting plate 8 is secured around the case by means of screws 9 and the mounting plate is in turn attached to the body of the instrument by screws 10. Within the case 5 the pickup includes an elongated bar 11 of permanent magnetic material. The bar is cushioned on the bottom of the case 5 by a felt strip 12 and is magnetized transversely from side to side rather than longitudinally along its length so that one side of the magnet constitutes a north pole and the other side constitutes a south pole. Positioned at longitudinally spaced intervals along both sides of the magnet 11 are pairs of upright cylindrical soft iron cores forming pole pieces 13 and 13A, there being a pair of pole pieces for each of the strings 2 of the instrument. At their lower ends the pole pieces abut against the side edges of the magnet 11 and are held in place by the magnetism of the magnet. The pole pieces 13 on one side of the magnet project through an elongated insulating bobbin 14 having a first coil 15 wound therearound in a plane parallel to the magnet and the surface of the instrument. A similar bobbin 14A surrounds the other line of pole pieces and has a coil 15A wound therearound. End flanges 16 on the bobbin are retained in place by engagement with the inside of the case 5 and screws 17 extending through the bottom of the case into the bobbins between the pole pieces.

The electrical connection between the coils 15 and 15A is best illustrated in Figs. 5 and 6 where the outer ends 18 and 18A of the coils are extended for connection to the previously described jack 4 on the body of the instrument. The inner ends 19 of the coils are electrically joined and the coils 15 and 15A are wound around the magnetic cores formed by the pole pieces 13 and 13A as illustrated. Viewed from one side of both coils, one coil 15 runs around the front of its core 13 from the connected inner ends 19 while the other coil 15A runs around the back of its core 13A. Careful consideration

3

of Fig. 6 will indicate that both coils extend about their cores or axes in the same direction from the connection 19. By applying the familiar right hand law of magnetism to the coil 15 it will be noted that an external magnetic field such as is indicated at 20 emanating from an electrical device such as the motor 21 will tend by induced voltage to create a current in the coil 15 in the direction of the arrow 22. However, the same magnetic field at the same instant will tend by induced voltage to create an approximately equal and opposite current in the coil 15A as indicated by the arrow 22A so that the induced currents cancel each other and cannot create a hum in the pickup and its associated amplifier. If the source of the interfering magnetic field is not centered between the coils or if the coils are not of identical construction cancellation of hum will not be complete but will be substantial. It should be noted that the particular winding of the coils illustrated is not critical because cancellation of interfering voltages can be obtained when the direction of winding of one coil is reversed if the inner or upper end of one coil is connected to the outer or lower end of the other coil.

The permanent magnet system created by the permanent magnet 11 and pole pieces 13 and 13A establishes north and south poles at the exposed ends of each pair of the pole pieces in proximity to the superimposed metal string 2 of the instrument and opposite poles are accordingly induced in the metallic string. Vibration of the string causes it to move over the ends of the pole pieces creating a variation in the magnetic field through the coils in a well known fashion. Since the pole piece 13 has a north pole at its upper end, variation in the strength of the magnetic field will tend to create a current in the coil 15 in the direction indicated by the arrow 23 in Fig. 6 and concurrent vibration over the pole piece 13A will tend to induce a current in the coil 15A in the direction indicated by the arrow 23A. The currents in the two coils thus are added together to provide a strong signal in response to the vibration of the string 2. The pickup thus filters out or eliminates the hum of unwanted interfering devices and creates a strong electrical impulse from the vibrating string for accurate reproduction of the sound of the instrument.

In the modified form of pickup shown in Figs. 7 and 8 the permanent magnet is formed in the shape of individual pole pieces 24. Three pole pieces A at one end of the pickup are mounted in a single bobbin 25 and have a coil 26 wound therearound. The other three pole pieces B are mounted in a second bobbin and have a coil 26A wound therearound. The coils 26 and 26A are offset longitudinally of the strings 2 and overlapped slightly at the adjacent ends of the coils due to their physical size. Overlapping is held to a minimum to reduce pick up or inductance between the two coils. The bobbins of the coils are connected by screws or rivets 27 to a mounting plate 28 and inclosed by a cover 29 through which the pole pieces project. Mounting bracket 30 is connected to the mounting plate 28 for mounting the pickup on the wall of the instrument 1. As in the preferred form of the pickup just described the coils 26 and 26A are connected to neutralize the effect of external magnetic fields on the pickup. Since each string of the instrument coacts with only one coil 26 of 26A there is no problem of the signal in one coil opposing the signal in the other.

In the modified form of pickup illustrated in Figs. 9 and 10 the pole pieces 31 again form the permanent magnet part of the pickup. The pole pieces are physically and magnetically connected to a bar 32 of magnetizable metal such as soft iron and the bar 32 is provided with oppositely extending core arms 33 and 33A that project through the centers of coils 34 and 34A. The coils 34 and 34A thus lie in planes parallel to the pole pieces 31 while in Figs. 7 and 8 the coils were in planes perpendicular to the pole pieces. Retaining plates 35

4

of magnetizable metal are bolted in contact with the ends of the core arms 33 and project upwardly along the outer sides of the coils to form partial magnetic return paths between the ends of the permanent magnet pole pieces 31. As with the other forms of the invention the inner ends of the coils 34 and 34A are electrically connected as at 36 and the coils are wound with respect to their common end to create opposing and neutralizing voltages under the influence of external magnetic fields. Each string of the instrument coacts primarily with only one or the other of the coils 34 or 34A. However, any incidental current induced in both the coils by vibration of any given string is additive in the outer ends 37 of the coils.

The modified form of the pickup shown in Figs. 11 and 12 is very similar to the form illustrated in Figs. 9 and 10. In place of individual pole pieces as permanent magnets, a continuous bar magnet 38 magnetized from its upper to its lower edge is employed. The coils 39 and 39A are bolted to opposite sides and opposite ends of the magnet 38 by bolts 40 and retaining plates 41 of soft iron. The bolts engage non-magnetic clamps 42. The bolts 40 and plates 41 create a magnet return circuit through the coils in association with the instrument string 2 so that the efficiency of the pickup is improved by utilizing more of the available magnetic flux in the permanent magnet.

The electrical and magnetic circuits employed in Figs. 9 to 12 are illustrated schematically in Fig. 13 with the strings 2 completing the magnetic path from one end of the permanent magnet to the end of the magnetic return structure. Again the coils are wound with respect to their connected ends to neutralize externally induced currents and hum. When viewed from the north pole of magnet 31 the coil 33A is wound clockwise about the magnetic core from the connection between the coils. Viewed from the same pole the coil 33 is wound counter clockwise from the connection between the coils so vibration of the string over the north pole of the core system creates additive currents in the coils. Considering both coils in series in a single external circuit and viewed from one end of the common axis through the coils, the wire winds or extends first in one direction about the axis to the connection between the coils and then reverses and winds the other way through the second coil to the other external lead. Thus an external magnetic field common to both coils induces opposing voltages in the two coils and the net external voltage due to the field is nil.

The examples of the pickups as shown in Figs. 6, 8 and 13 have a common feature in that the two coils are wound oppositely from their common connection with respect to an axis or line common to both coils. That is, a line, which may represent an external line of flux from an interfering device, has one coil extending in a clockwise direction from the connection with respect to the flux field or line while the other coil extends in a counter clockwise direction with respect to the same line. In Figs. 6 and 8 the hypothetical common flux line may extend between the physical axes of the two coils and generally parallel therewith while in Fig. 13 the flux line generally coincides with the physical axes of the two coils which are aligned. For best results the physical axes of the two coils are parallel so that the external flux field will affect both coils approximately equally as the pickup and its coils are moved with respect to the interfering device. However, the physical axes of the two coils may vary somewhat from true parallelism and still be approximately equally and oppositely affected by an external magnetic field.

The examples illustrated in Figs. 6 and 13 have a further feature in common in that the magnetic core or path of permanent magnetism through the two coils has a pole, which incidentally forms the pole tip associated with the string of the instrument, that is common to each

5

coil. The two coils are wound or disposed about this magnetic core or path in like directions from the connection between the coils when viewed from this common pole so that variations in the permanent magnetic field through the core induces like additive voltages in the two coils. In Fig. 6 the north pole of the magnetic core 13, 11, 13A is common to both coils as the core is a single continuous path. In Fig. 13 the north pole of magnet 31 is common to both coils even though the magnetic core divides into two separate paths. The example shown in Figs. 7 and 8 does not create additive voltages in the coils as there is no common core means through both coils and each string acts only on a single coil.

Having thus described my invention what I claim as new and desire to secure by Letters Patent is:

A magnetic pickup for a stringed musical instrument comprising an elongated permanent bar magnet magnetized from side to side, a plurality of pairs of cylindrical pole pieces of magnetizable soft iron material arranged at spaced intervals along said magnet with the pieces of each pair engaging opposite sides of the magnet and projecting thereabove, a first coil wound around all of the pieces on one side of said magnet, a second

6

coil wound around all of the pieces on the other side of the magnet, one end of each coil being electrically connected to the end of the other with the coils extending in a clockwise direction about each group of pole pieces from the connection, means connected to said coils for connecting the other ends of said coils to an amplifier, and a case of non-magnetic material enclosing said magnet, pole pieces and coils, said case being adapted to be secured to a stringed musical instrument with each string of the instrument passing over a different pair of said pole pieces.

References Cited in the file of this patent

UNITED STATES PATENTS

Re. 20,070	Lesti	Aug. 18, 1936
2,119,584	Knoblauch	Jan. 7, 1938
2,262,335	Russell	Nov. 11, 1941
2,542,271	Alvarez	Feb. 20, 1951
2,581,653	Grimshaw	Jan. 8, 1952
2,683,388	Keller	July 13, 1954

FOREIGN PATENTS

817,992	Germany	Oct. 22, 1951
---------	---------------	---------------